





# ACCESSORIES

## CLIPS

	TYPE OF CLIP	MATERIAL	SUITABLE FOR PROFILE						
			PREMIUM	MAX	TOP	AMBIENTE	STEP	150 x 19	137 x 23
	START CLIP	STAINLESS STEEL A2 / A4	X	X	X	X	X	X	
	STANDARD CLIP	STAINLESS STEEL A2 / A4	X	X		X	X	X	
	DOUBLE CLIP	STAINLESS STEEL A2 / A4	X			X	X	X	
	TOP STANDARD CLIP	STAINLESS STEEL A2			X				
	DOUBLE-SIDED CLIP PRO TOP	STAINLESS STEEL A2			X				
	CLICK CLIP START	STAINLESS STEEL A2	X	X	X	X	X	X	
	AL STANDARD CLIP	ABS/ STAINLESS STEEL A2	X	X		X	X	X	X
	AL START CLIP	METAL	X	X	X	X	X	X	X
	ECO CLADDING STANDARD CLIP	STAINLESS STEEL A2	ECO CLADDING PROFILE						
	ECO CLADDING START CLIP	STAINLESS STEEL A2	ECO CLADDING PROFILE						

## JOISTS

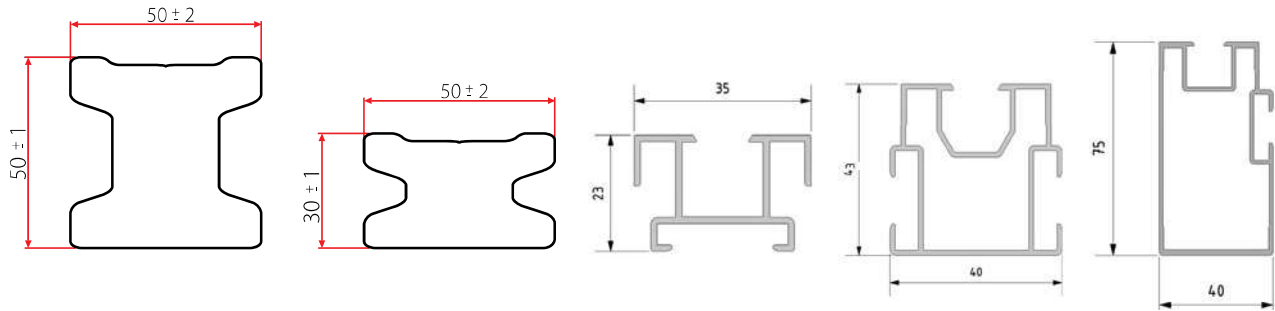

PROFILE	DIMENSIONS	LENGTH	MATERIAL	WEIGHT
LARGE JOIST	50 x 50 mm	3 m / 4 m	WPC	2.3 kg / lm
SMALL JOIST	50 x 30 mm	3 m / 4 m	WPC	1.4 kg / lm
SMART* 23 x 35	23 x 35 mm	4 m	ALUMINIUM	0.4 kg / lm
SMART* 40 x 43	40 x 43 mm	4 m	ALUMINIUM	0.7 kg / lm
SMART* 75 x 40	75 x 40 mm	4 m	ALUMINIUM	1.1 kg / lm

\* MORE INFORMATION ABOUT SMART ALUMINIUM SYSTEM ON THE SEPARATE SHEET

## FINISHING BOARDS

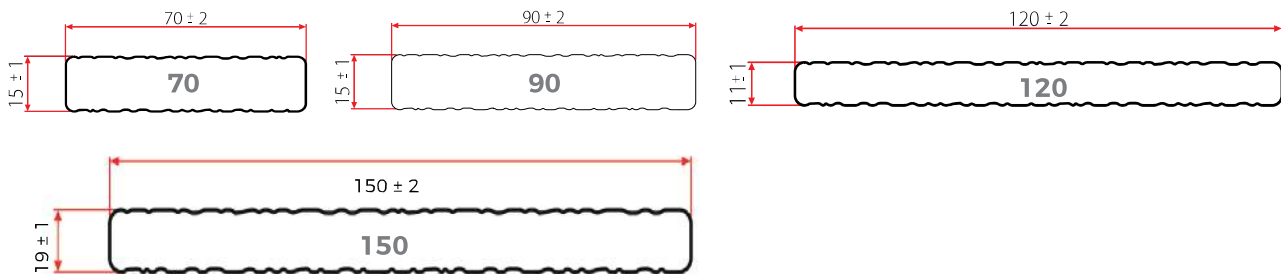

PROFILE	DIMENSIONS	LENGTH	WEIGHT	DESIGN
70 / SMALL	70 x 15 mm	2 m	1.4 kg / lm	STYLE / FOREST
90 / MEDIUM	90 x 15 mm	2 m	1.7 kg / lm	STYLE / FOREST
120	120 x 11 mm	3 m	1.7 kg / lm	FOREST / RUSTIC
150	150 x 19 mm	4 m	3.4 kg / lm	FOREST / RUSTIC

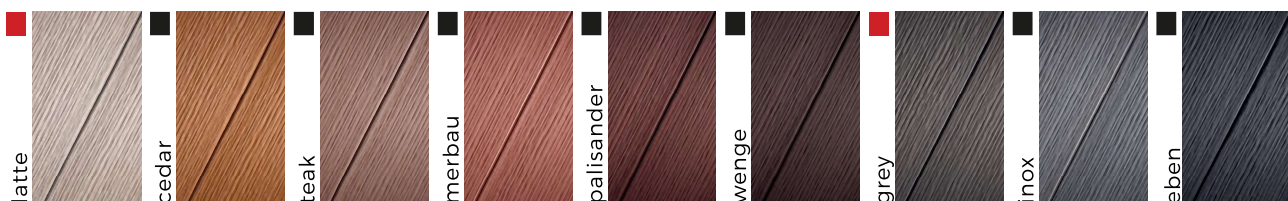

■ IN STOCK

■ CUSTOM ORDER